

**G26.35**

## SCHEDA DI INSTALLAZIONE

### VISTA FRONTALE

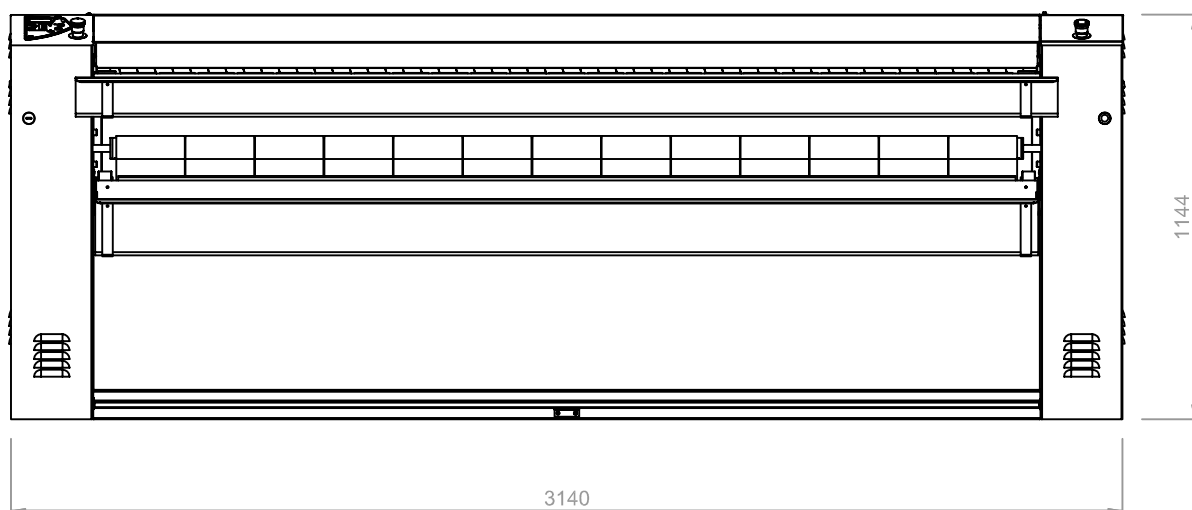

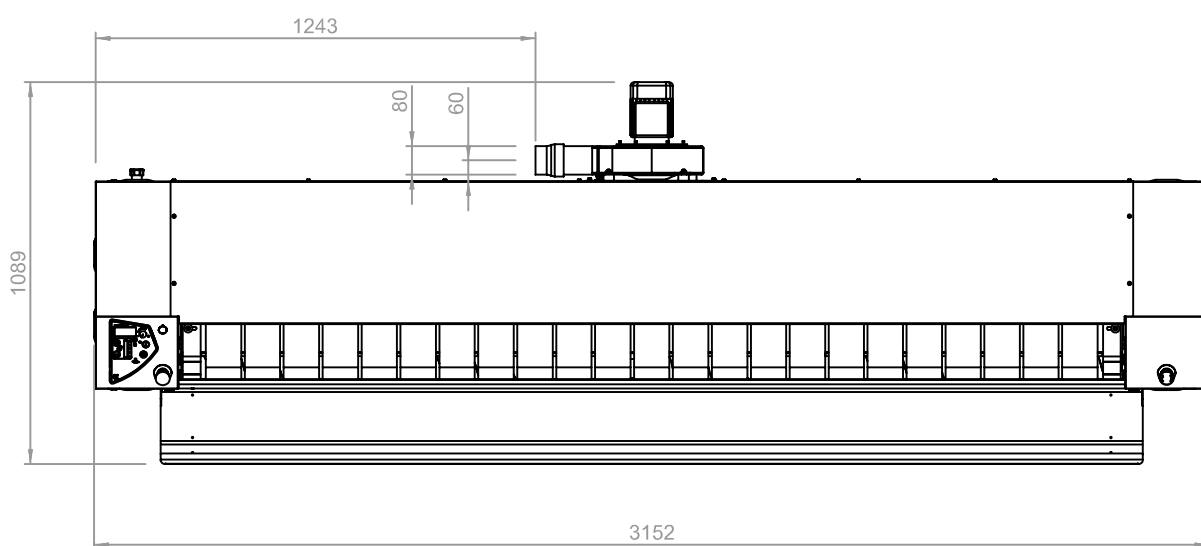

### VISTA DALL'ALTO

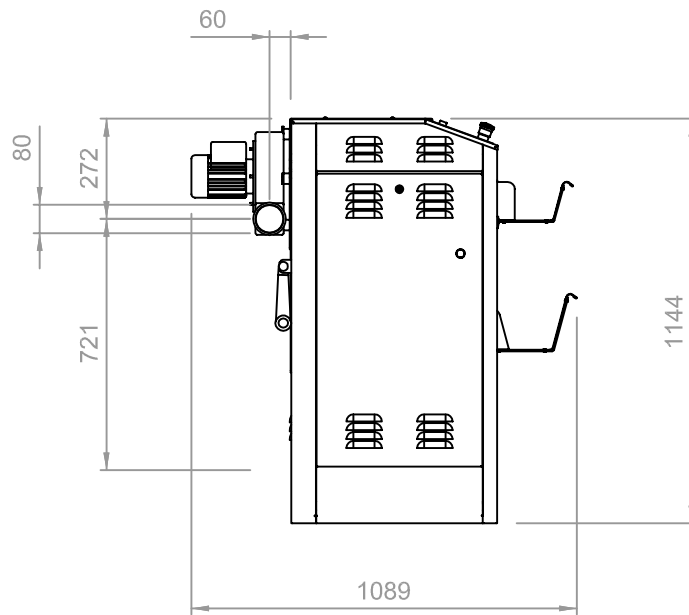
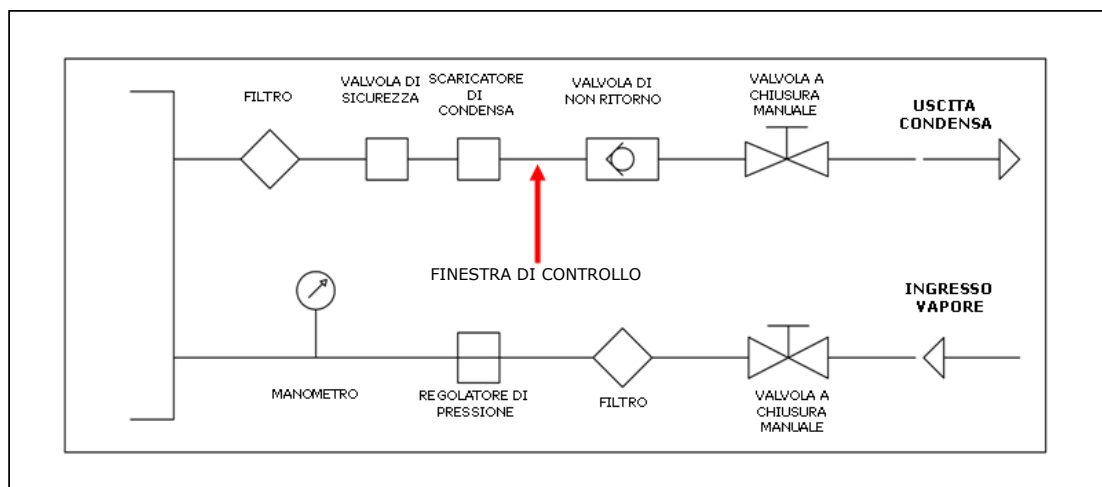

**SCHEDA DI INSTALLAZIONE****VISTA LATERALE****REQUISITI IMPIANTO VAPORE**

## REQUISITI

Cavo elettrico + spina industriale			
	V.230/1/50Hz	V.230/3/50Hz	V.400/3N/50Hz
	5 A	non disponibile	non disponibile
Potenza del motore	1 kW	-	-
Interruttore magnetotermico differenziale	I <sub>dn</sub> = 0.03 A	-	-
Collegamento vapore	G 3/4" M	-	-
Consumo medio vapore	32 kg/h	-	-
Pressione minima vapore richiesta	4 bar	-	-
Scarico vapori	Ø80 mm, 280 m <sup>3</sup> /h	-	-
Scarico condense	G 3/8" M	-	-
Spazio libero necessario attorno alla macchina	dietro: 500 mm - a destra: 500 mm - a sinistra: 500 mm		